

1.a

1.b

1.c

1.d

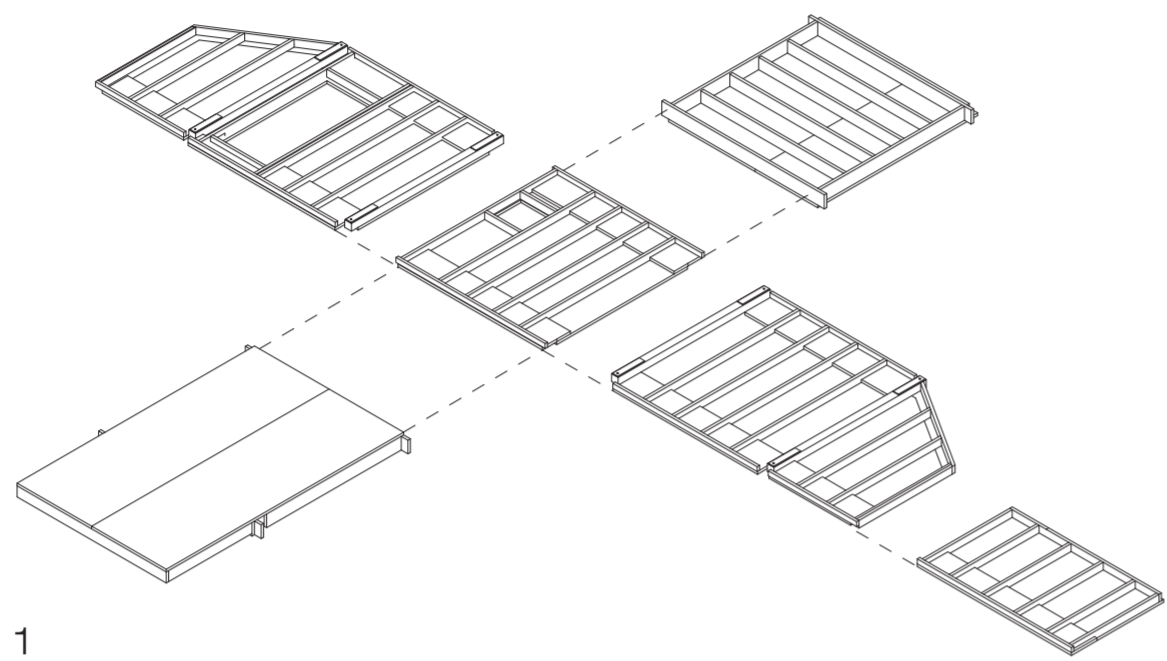

1

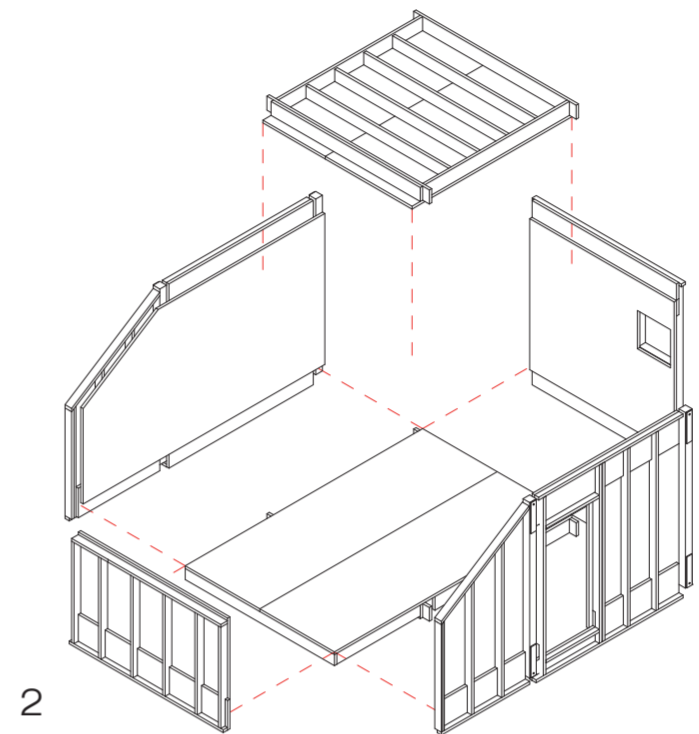

2

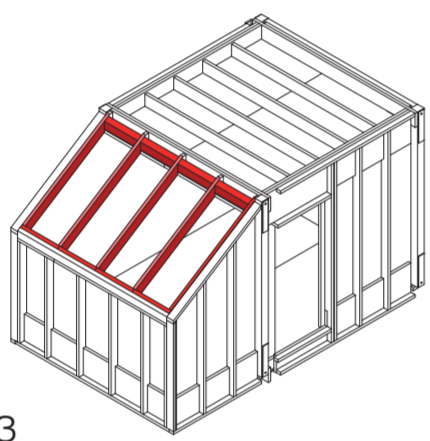

3

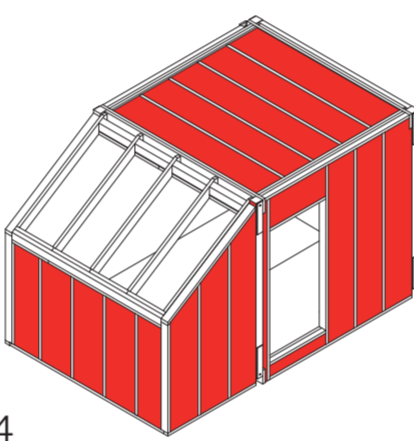

4

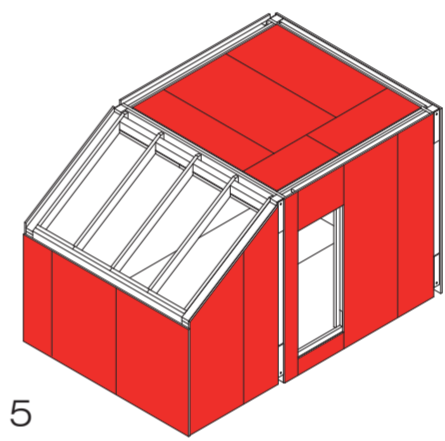

5

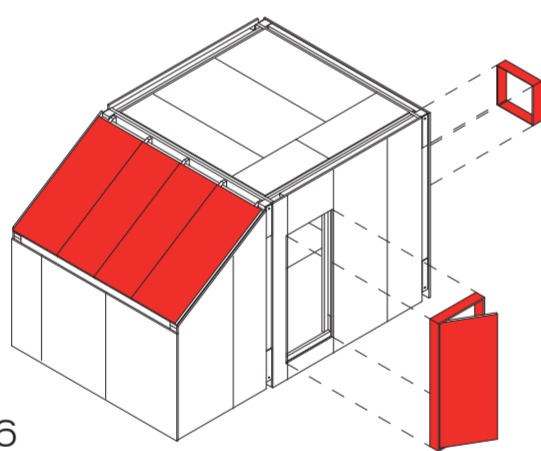

6

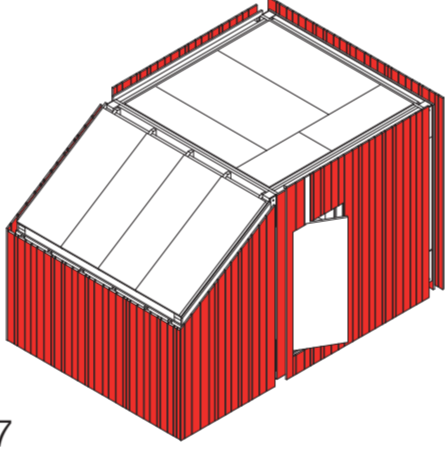

7

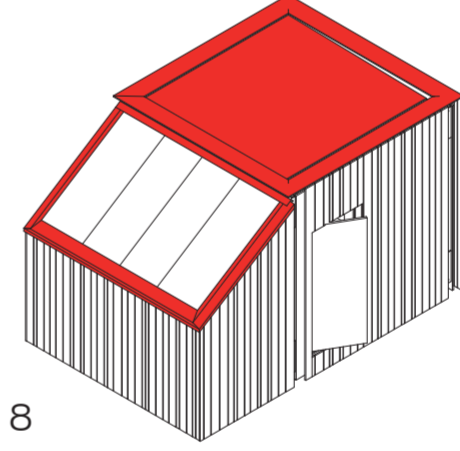

8

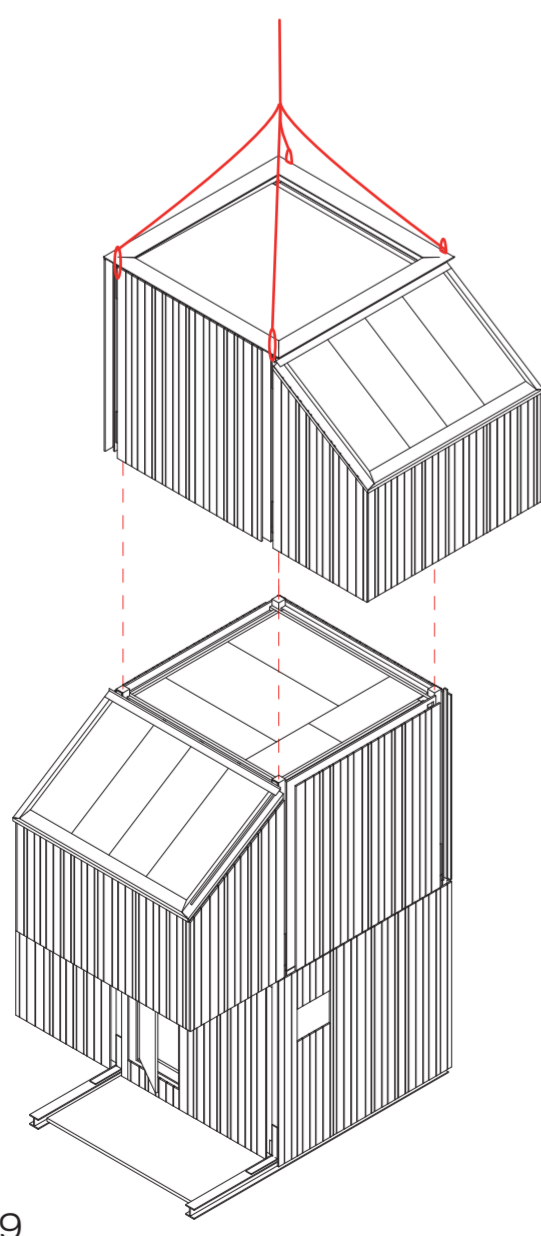

9

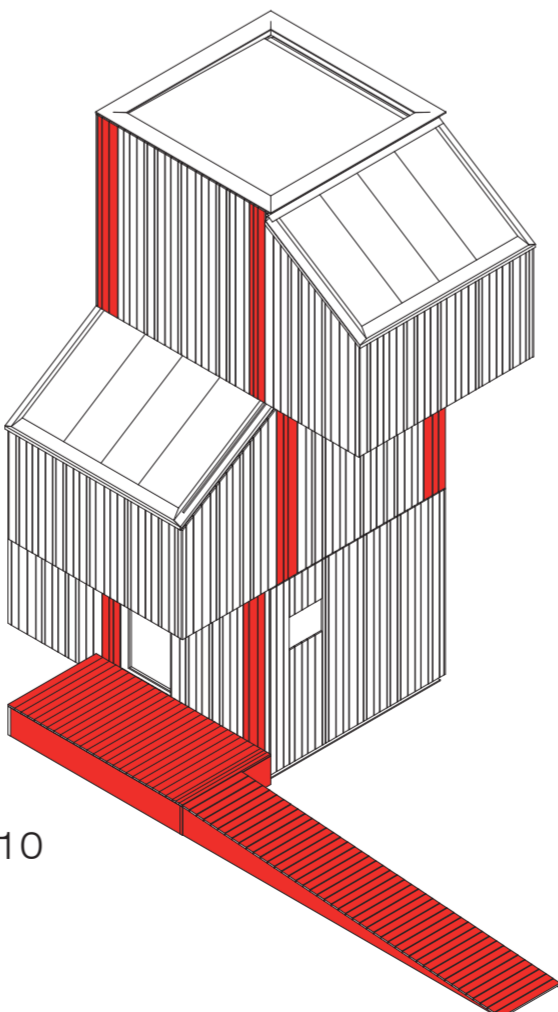

10

1. Flat assembly
 - a. Columns on LVL panel
 - b. LVL skirting beams
 - c. LVL studs
 - d. Steel plates
2. Structure assembly
3. IGU glulam frame
4. Blown insulation
5. Windbarrier board and plywood
6. Openings
7. Cladding
8. Flashing and roofing
9. Stacking
10. Finishing